



PORSELEN DUŞ KAROSU
PORCELAIN SHOWER TILE

seranit

AQUANIT PORSELEN DUŐ KAROSU

AQUANIT PORCELAIN SHOWER TILE

Banyolarda hijyene giden en kolay yol...

The easiest way to hygiene in bathrooms...



İÇİNDEKİLER

Index

- 12** Ürünler
Products
- 16** Renk Alternatifleri
Color Alternatives
- 18** Uygulama Adımları
Application Steps
- 20** Teknik Bilgiler
Technical Drawings

Aquanit

Porselen Duş Karosu

AQUANIT PORCELAIN SHOWER TILE



Daha konforlu bir yaşam için daha işlevsel çözümler bulmak, iyi tasarımlar kullanmak herkesin temel ihtiyacı. Banyolarda yaşanan kazaların büyük bir kısmı ayak kaymaları ya da yıkanma alanına girerken atılan o büyük adımlardan kaynaklanıyor. **Artık banyolarda AQUANIT ile konforlu ve engelsiz bir ortam yaratmak mümkün.**

Finding more functional solutions and using well-designed goods are everyone's basic needs for a more comfortable life. Most of the accidents in bathrooms are caused by slipping or those big steps taken while entering the shower area. It is now possible to create comfortable and unobstructed bathrooms with AQUANIT.

Zorlanmadan, pratik bir şekilde doğrudan duş alanına girebileceğiniz,

hemzemin tasarımı ile banyoda ferah ve modern bir tasarım yaratan **Seranit'ten inovatif çözüm: Aquanit Porselen Duş Karosu**

An innovative solution from Seranit, which creates a spacious and modern design in the bathroom with its same-level design, where you can enter the shower area directly without any difficulty: Aquanit Porcelain Shower Tile

Banyolarda hijyene giden en kolay yol...

The easiest way to hygiene in bathrooms...



Günümüzde evdeki herkes için hem ortak alan hem de özel alan sayılabilecek alanlardan biri olan banyolar, kişisel tercihlere göre farklılık gösterebiliyor. Evlerde, otellerde, hastanelerde, spor salonlarında ve duş alınan diğer birçok alanda, **estetik ve fonksiyonel alanlar yaratmak için kullanılan Aquanit Porselen Duş Karosu pratik, sağlıklı ve engelsiz bir banyo deneyimi için ideal** bir seçenek oluyor. Uzun ya da kısa süreli rahatsızlıkları bulunan insanlar, **engelliler ve yaşlıların günlük temizlik ihtiyaçlarını kendi başlarına görmelerini kolaylaştıracak akıllı çözümler** artık banyoların tüm alanlarında uygulanıyor.

*Bathrooms, which are one of the areas that can be considered both a common and a private space for everyone at home, differ according to personal preferences today. Aquanit Porcelain Shower Tile, which is used to create **aesthetic and functional** spaces in homes, hotels, hospitals, gyms and many other areas where we take shower is an ideal option for a practical, healthy and unobstructed bathroom experience. **Smart solutions are now applied in all areas of bathrooms, making it easier for people with long or short-term illnesses, the disabled, and the elderly to meet their daily cleaning needs on their own.***

100%
PORCELAIN

Porselen Karo

%100 Porselen olan ve porselenin tüm özelliklerini banyolara taşıyan Aquanit, kullanıldığı tüm yıkanma alanlarında, alternatif malzemelere göre porselenin avantajı ile uzun yıllar renk ve desen yapısını korumaya devam ediyor.

Porcelain Tile

100% porcelain Aquanit, which offers all the properties of porcelain to bathrooms, continues to preserve its color and pattern structure for many years in all shower areas where it is used, with the advantage of using porcelain compared to alternative materials.



Kolay Uygulama

Aquanit, kolayca uygulanabilecek şekilde tasarlanmıştır.

Tek parçadan oluşan gövdesi ile gider ve sifon elemanları hızlı ve zahmetsiz bir şekilde montajlanır.

Easy Application

Aquanit has been designed to be easily applied. With its single-piece body, outlet and siphon elements are conveniently installed.

Banyolarda hijyene giden en kolay yol...

The easiest way to hygiene in bathrooms...



Kaydırmaz

Üretimden gelen özel kaydırmaz yüzeyi ile **ailedeki tüm bireylerin banyoda kaymadan risksiz bir şekilde yıkanması mümkün.** Böylece hijyenik olmayan kaydırmazlık sağlayan malzemelerin de kullanılmasına gerek kalmıyor.

Anti-Slip

As it is produced with a special non-slip surface, it is safely possible for all members of the family to take a shower in the bathroom without slipping. Thus, the unhygienic anti-slip materials are not needed for the application anymore.

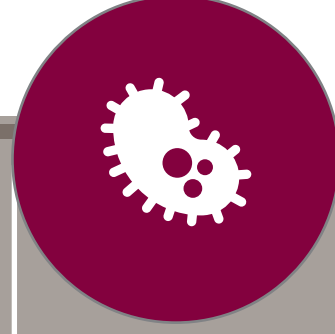

Hijyenik

Eski tip duş kanallarına göre kirlerin birikebileceği alanları azaltan gider tasarımıyla ve tek parça derze ihtiyaç duymayan yapısıyla, hijyenin çok kritik olduğu duş alanında **tam hijyen sağlıyor.**

Hygienic

It provides complete hygiene in the shower area, where it is very critical, with its drain design that has minimized the areas where dirt can accumulate compared to old-style shower channels and its one-piece structure that does not require any jointing.

Aquanit

Porselen Duş Karosu.

AQUANIT PORCELAIN SHOWER TILE



Entegre Gider Sistemi

Yüzeyinin kendi içerisinde gidere doğru eğimli olması sayesinde **yıkama alanında su birikimi olmuyor, su dışarıya taşmıyor**. Kendine özel entegre gider sistemi sayesinde su sızdırmayan yapısıyla banyonuzda güvenle kullanılıyor.

Integrated Drain System

As its floor is inclined towards the drain, there is no accumulation of water in the shower area, and the water does not overflow. Thanks to its unique integrated drain system, it can be used safely in your bathroom with its water-proof structure.



Leke Tutmaz

Porselen karonun bir özelliği olarak su emme değeri sıfıra yakın olması ile kir ve leke tutmuyor. **Kimyasallara karşı dayanıklılığı sayesinde banyo temizliğini kolaylaştırıyor**.

Stain-proof

Due to the feature of the porcelain tile, its water absorption value is close to zero and it is dirt and stain proof. Thanks to its resistance to chemicals, it makes cleaning the bathroom much easier.

Banyolarda hijyene giden en kolay yol...

The easiest way to hygiene in bathrooms...



Hemzemin Döşeme

Duş bölmesinin, banyo dolaşım alanından kesintisiz bir yüzeyle ayrılması ve kaymaz (ıslak/kuru) bir kaplamaya sahip olması çok önemli. **Aquanit hemzemin tasarımı ile eşik ve kot farkı olmadan** çocukların, yaşlıların ve engellilerin destek bir malzeme ile de (yürüteçleri veya tekerlekli sandalyeleri ile) duş alanına çok daha kolay girmesini sağlıyor.

Level Flooring

It is very important that the shower area is smoothly separated from the rest of the bathroom area with a floor that has a anti-slip (wet/dry) coating. Aquanit, with its level flooring design that has no threshold or level difference enables both the elderly and the disabled to enter the shower area much more easily with the help of a supporting material (with walkers or wheelchairs).



Türkiye'nin ilk ve tek porselen duş karosu Aquanit'in mermer, beton, ahşap gibi desen çeşitliliği sayesinde **banyolarınızda bir tasarım bütünlüğü oluşturuyor.**

Turkey's first and only porcelain shower tile, Aquanit, creates a design integrity in your bathrooms thanks to its various patterns such as marble, concrete and wood.

Aquanit

Porselen Duş Karosu.

AQUANIT PORCELAIN SHOWER TILE



KULLANIM ALANLARI / USAGE AREAS



OTEL / HOTEL



HASTANE / HOSPITAL



KONUT / RESIDANCE



DIŐ MEKAN / OUTDOOR



Slope

90x135cm - 80x120cm - 90x90cm - 80x80cm*

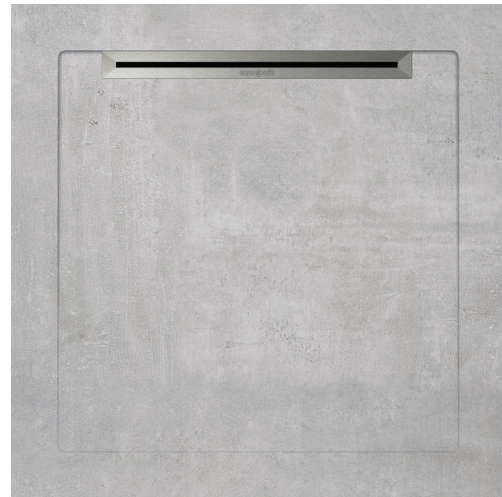
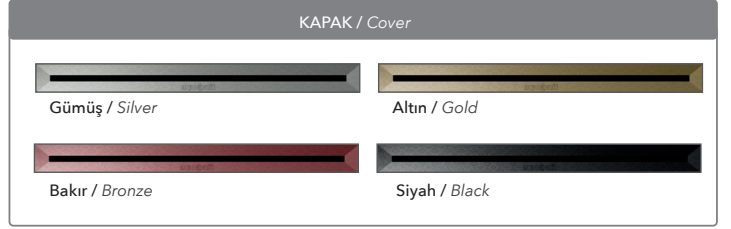

* 80x80 ebat, yalnızca 200 adet ve üzeri siparişlerde üretilmektedir.

* 80x80 size is only produces for order of 200 pieces or more.



Slope Nova

90x135cm - 80x120cm

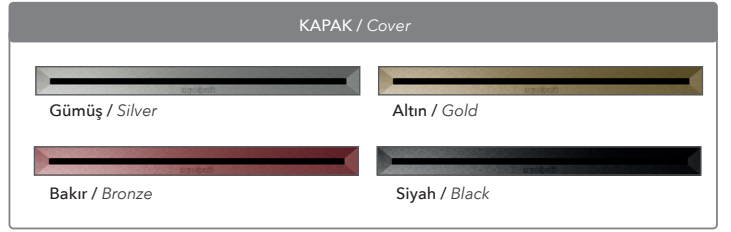

Renk Alternatifleri / Color Alternatives



AGATHA
Kemik / Bone



AGATHA
Gri / Grey



ARC
Gri / Grey



ARC
Vizon

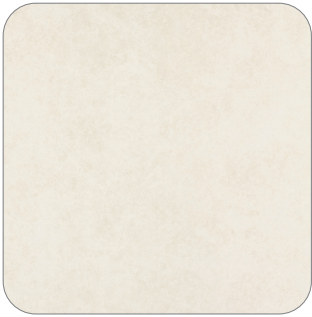

ARC
Beyaz / White



BETON
Antrasit / Anthracite



BETON
Krem / Cream



BETON
Gri / Grey

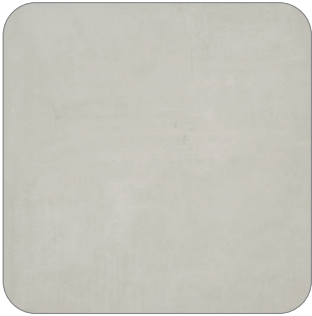

BETON
Beyaz / White



CODE 529 HILL
Antrasit / Anthracite



CODE 529 HILL
Beyaz / White



FIBRE
Gri / Grey



ETNA
Gri / Grey

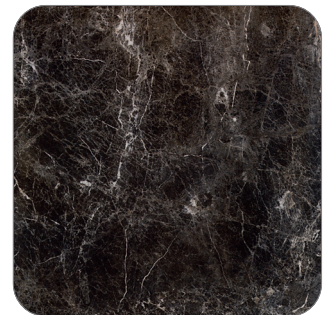

ETNA
Antrasit / Anthracite

Renk Alternatifleri / Color Alternatives

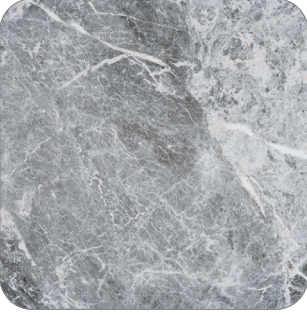

FIORI DI PESCA
Gri / Grey



FIORI DI PESCA
Beyaz / White

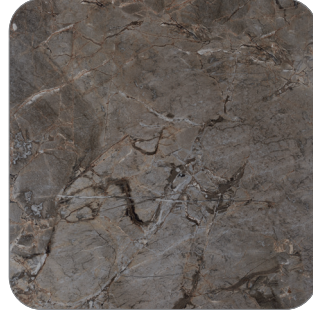

GUSTO
Taupe Gri / Taupe Grey



HAVANA
Beyaz / White



INFINITY
Beyaz / White

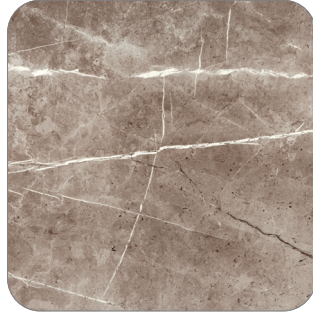

LUXOR
Kahve / Brown



MARMO BIANCO
Beyaz / White



MOLD
Bazalt / Basalt



MOLD
Grit / Grit



OAKWOOD
Açık Kahve / Light Brown



PARIS
Gri / Grey

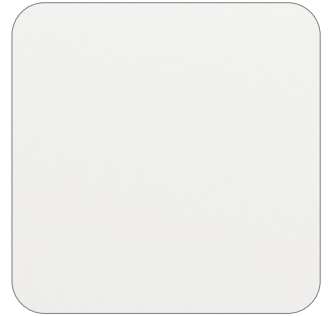

SERENA SUPER WHITE
Beyaz / White



SERENITY
Beyaz / White



SERPEGIANTE
Beyaz / White

Uygulama Adımları / Application Steps



1 Ülke standartlarına uygun olarak izolasyon yapılır.
Insulation should be made according to country standards.



2 Aqanit modeline göre aks ölçüsü alınır ve sifon yeri belirlenir.
Measure the siphon axis and locate the siphon according to the technical drawing of the specific Aqanit product.

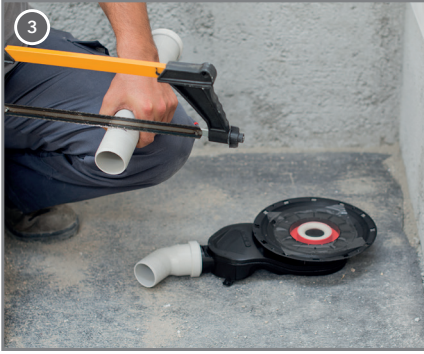

3 Sifonla sifon arasını bağlayacak uzatma parçası kesilir.
Cut extension piece that interconnect one siphon to another one.



4 Tamir harcı konulur. Sifon, sifon yuvasına yerleştirilir.
Apply repair mortar. Place the floor siphon into the housing.

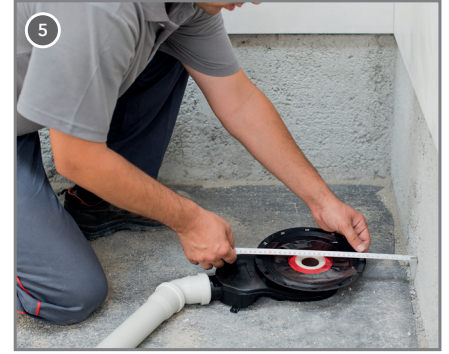

5 Sifon aks ölçüsü ayarlanır ve kontrol edilir.
Set and check the siphon axis measurement.

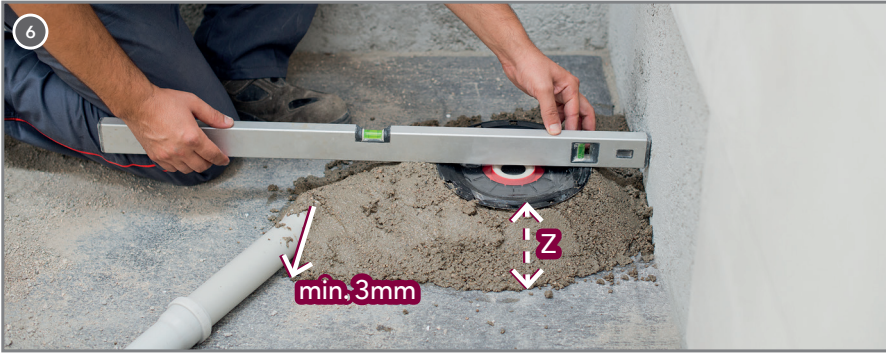

6 Su terazisi ile şap ve sifon aynı seviyeye gelecek şekilde seviye kontrolleri yapılır. Pis su borusuna minimum 3 mm eğim verilmesi önerilir.
Check the screed and the siphon are on the same level. Beveling the waste pipe at least 3 mm is recommended.



7 İzolasyon uygulamasından önce şapın prizini almış olması gerekir.
The setting screed should have been set before the isolation process.



8 Ülke standartlarına uygun olarak izolasyon yapılır.
Insulation should be made according to country standards.



9 Aqanit porselen duş karosu montajı için hazırlanan porselen yapıştırıcı zemine sürülür.
Spread the porcelain adhesive on floor which is prepared for installation of Aqanit porcelain shower tile.



10 Koruyucu film yerinden çıkarılır.
Displace the protective film.

Uygulama Adımları / Application Steps



Sifon içerisinde bulunan eksantrik parça ayar yapılır.
Adjust the eccentric part in siphon.



Aquanit Porselen Duş Karosu arkasına porselen yapıştırıcı sürülür.
Apply porcelain adhesive to the back side of Aquanit porcelain shower tile.



Aquanit Porselen Duş Karosu yerine konulur. Gidere doğru 2-3 mm eğim önerilir.
Place Aquanit Porcelain Shower Tile. Beveling 2-3 mm towards drain is recommended.



Sifonun aksa gelmesi için gider boşluğundan eksantrik ayar yapılır.
Perform eccentric adjustment from the drain gap to align the floor siphon with the axis.



Sabitleme parçası ile sifon, sisteme sabitlenir.
Fix the floor siphon to the system using the fixation piece.



Helezon saç tutucu yuvasına yerleştirilir.
Place the spiral hair trap into its housing.



Kapak montajı yapılır.
Install the cover.

Uyarılar

- Dikkat: Uygulama bitirilene kadar sifon yüzeyindeki koruyucu film kesinlikle sökülmemelidir.
- Uygulamaları, verilen uygulama kılavuzu doğrultusunda yapınız.
- Uygulamadan önce kusur olup olmadığı kontrol edilmelidir. Montaj sonrası sorumluluk kabul edilmez.
- Kesme delme işlemleri mutlaka fabrikada yapılmalıdır.
- Uygulama öncesi daha detaylı bilgi için web sitemizden (seranit.com.tr) bize ulaşabilirsiniz.

Warning

- Do not rip off the protective cover film of siphon the whole application is finished.
- Carry out the processes as explained in the application manual.
- Before installation of the product, it should be checked whether it has defect. No responsibility will be taken after installation.
- Cutting and drilling processes should have been done at the factory prior to installation.
- You can contact us through our website (seranit.com.tr) for more detailed information before the application.

Montaj adımları, tüm modeller için hazırlanmıştır. Installation steps have been prepared for all models.

Slope Model - 90x135cm

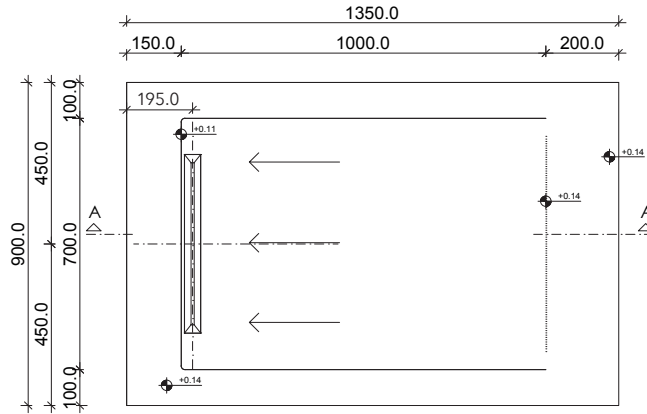

Slope Model - 80x120cm

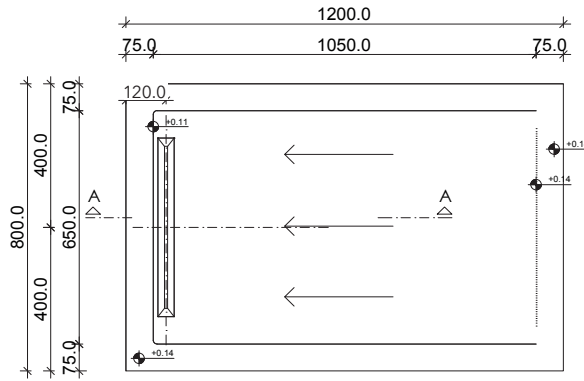

Slope Model - 90x90cm

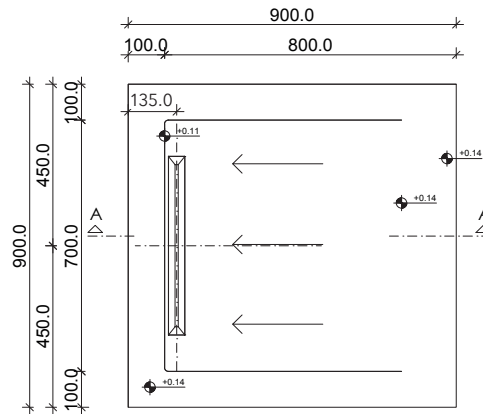

Teknik çizimlerde hemiyüz uygulama alternatifi baz alınmıştır.
Technical drawings are based on the level application alternative.

Slope Model - 80x80cm

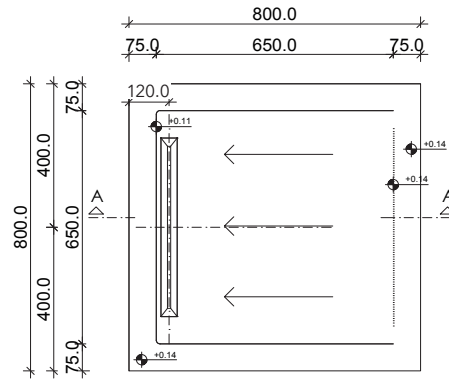

Slope Nova Model - 90x135cm

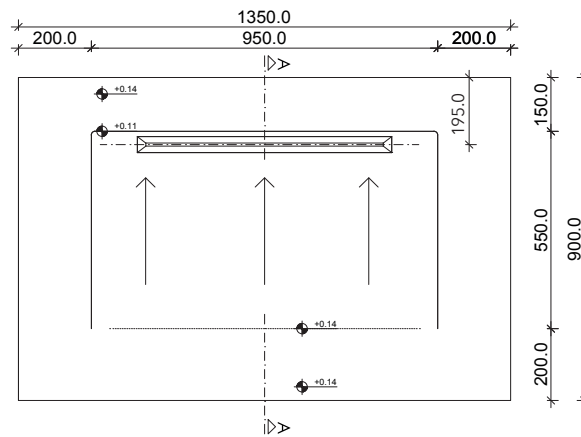

Slope Nova Model - 80x120cm

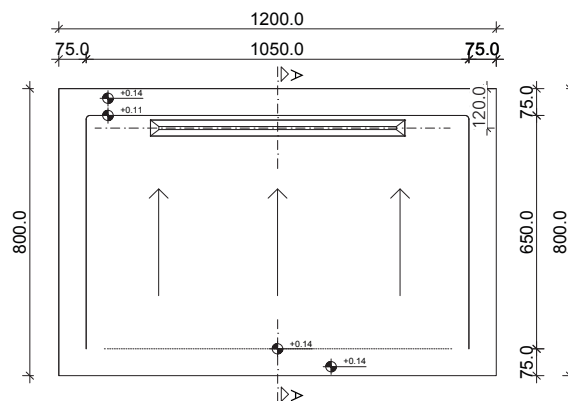

Teknik çizimlerde hemyüz uygulama alternatifi baz alınmıştır.
Technical drawings are based on the level application alternative.



Zemin Kot Farkı Uygulamaları / Floor Applications With Level Difference

Alternatif 1 / Alternative 1

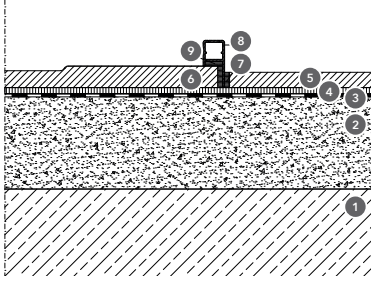

Alternatif 2 / Alternative 2

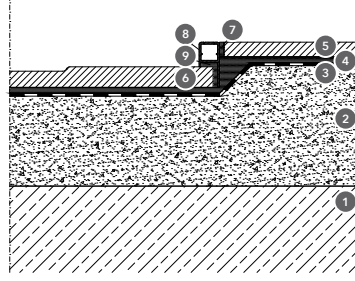

Alternatif 3* / Alternative 3*

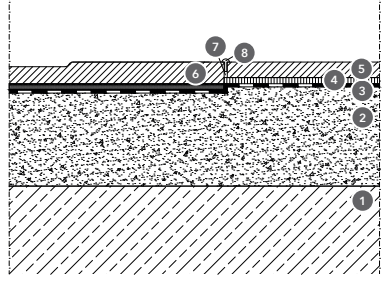

- 1 Betonarme döşeme / Concrete floor
- 2 Zemin tesviye şapı / Leveling screed
- 3 Islak mekan sürme izolasyon / Wet insulation drive space
- 4 Flex yapıştırıcı 10 mm / 10mm flex adhesive
- 5 Seranit yer karosu 10 mm, 3mm fuga / Seranit floor tile 10 mm, 3mm grouting fuga
- 6 Aquanit 14mm / Aquanit 14mm
- 7 Flex derz dolgu 3mm fuga / 3mm grouting fuga
- 8 Su izolasyon ve kabin profili / Water insulation and cabin profile
- 9 Polime sızdırmazlık / Polymer sealing

Zemin tesviye şapı yüksekliği, kullanılacak sifon modeline göre değişebilir. / The floor's leveling screed height may vary depending on the siphon model to be used.

Uygulama alternatifleri, tercih edilen döşeme kotlarına göre değişebilir. / The type of application may vary depending on the preferred elevation.

* Sadece kapalı duş kabinleri ile kullanılabilir.

* Can be used only with closed cabinet.

Aquanit Porselen Duş Karosu Montajı İçin Aks Ölçüleri / Axis Dimensions for Aquanit Ceramic Shower Tile Installation

Ürün ve Ebat / Product & Size		
	Slope Model	Slope Nova Model
800x800	X = 125 ; Y= 400	
900x900	X = 140 ; Y= 450	
800x1200	X = 125 ; Y= 400	X = 125 ; Y = 600
900x1350	X = 200 ; Y= 450	X = 200 ; Y = 675

Ölçüler seramik altı sıvadan verilmiştir.

Dimensions are given from under ceramic plaster.

Uygulama Detayları / Application Details

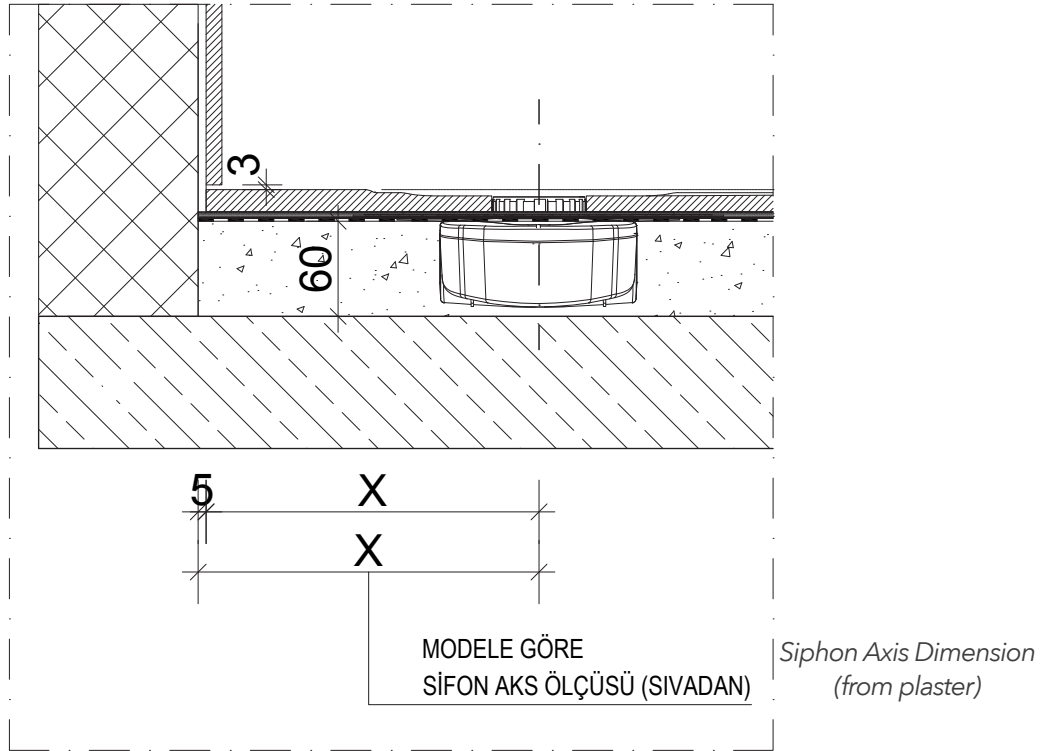

Cabine Profile

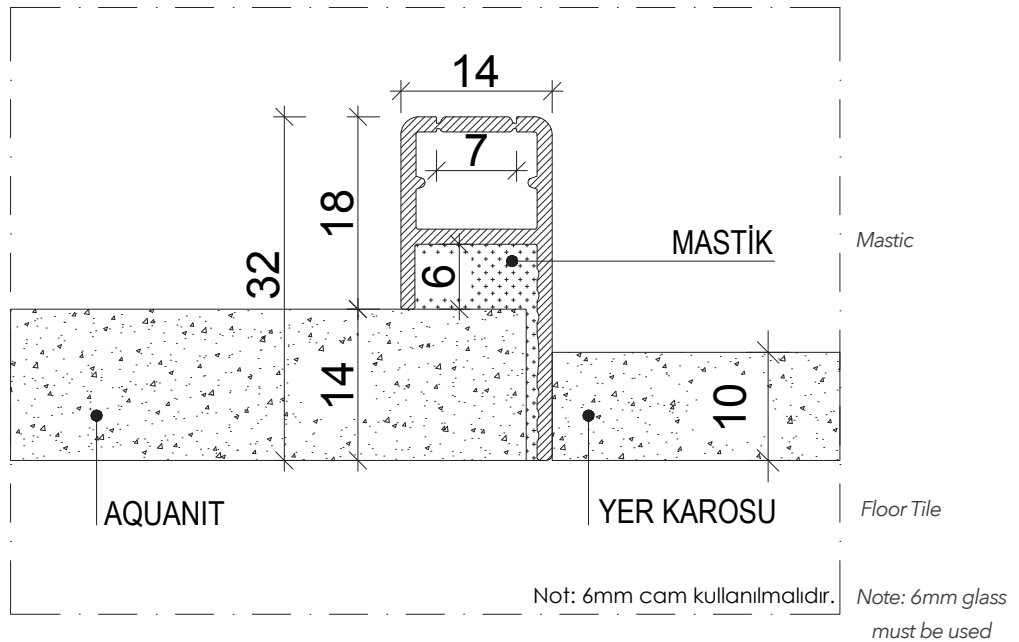

Teknik Bilgiler / Technical Informations

Uygulama Kesitleri / Application Profiles



36 l/dk. Yandan Çıkışlı Sifon
60 mm. Yükseklik
Uygulama Kesiti
(Min. 60mm şap yüksekliği)

36 l/min. Side Outlet Siphon
60mm Height
Application Profile
(Min. 60mm screed height)

Aquanit 14mm 1

Flex yapıştırıcı 4 mm 2
Flex adhesive

Islak mekan sürme izolasyon 3
Wet surface applied insulation

Yalıtım flanşı 4
Insulation flange

Zemin tesviye şapı 5
Floor leveling screed

Sifon 6
Siphon

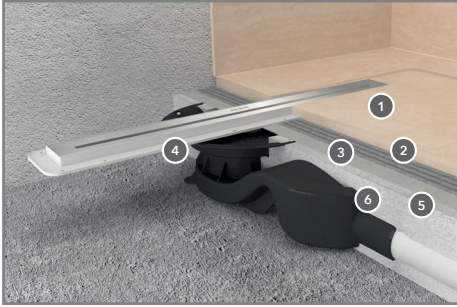

60 l/min. Yandan Çıkışlı Sifon
80mm Yükseklik
Uygulama Kesiti
(Min. 80mm şap yüksekliği)

60 l/min. Side Outlet Siphon
80mm Height
Application Profile
(Min. 85mm screed height)

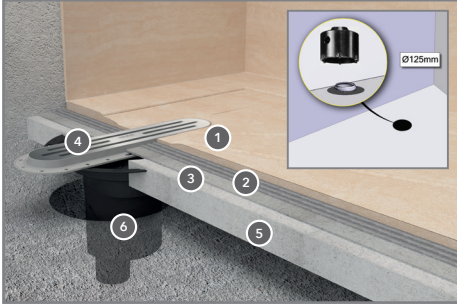

48 l/min. Alttan Çıkışlı Sifon
Uygulama Kesiti
(Min. 30mm - max. 80mm şap yüksekliği)

48 l/min. Vertical Outlet Siphon
Application Profile
(Min. 30mm - max. 80mm screed height)

Beton, 125 mm çapında karot ile kesilmelidir.
The concrete must be cut with a drill of 125mm in diameter.

Kutu Palet Bilgileri / Box Pallet Information

Boyut Size(cm)	Net Ölçü Net Dimension	Kalınlık Thickness	Kutu /ad. Box / pcs	Kutu (m ²) Box (m ²)	Kutu Box	Palet (m ²) Pallet (m ²)	Kutu (kg) Box (kg)	Palet (kg) Pallet (kg)	Palet Ebadı(cm) Pallet Size (cm)
80x80	800x800	14	1	0.64	9	5.76	21	233	99x99x76
80x120	800x1200	14	1	0.96	9	8.64	31	330	99x139x76
90x90	900x900	14	1	0.81	9	7.29	26	282	108x108x76
90x135	900x1350	14	1	1.215	9	10.94	39	415	109x154x76

Sifon / Siphon

Kutu adet / Box - pcs

60 mm Yandan Çıkışlı Gider Sistemi / 60mm Side Outlet Drain System	9
80 mm Yandan Çıkışlı Gider Sistemi / 80mm Side Outlet Drain System	9
30/80mm Alttan Çıkışlı Gider Sistemi / 30/80mm Vertical Outlet Drain System	9

Talep edilen sifon müşteriye ayrı palet üzerinde gönderilmektedir. Requested siphon is shipped to the customer on a separate pallet.



Turkish Standards Institution
Certificate Of Conformity To Double
Star Criteria



TS EN 14411
Certificate of Conformity to Turkish Standards



ISO 9001 Certificate



Occupational Health And
Safety Management System Certificate



Environmental Management
System Certificate



Environmental Management
System Certificate



ISO 9001 Quality Management
System Certificate



Occupational Health And
Safety Management System Certificate



Environmental Product Declaration, EPD



Russia - Gost Certificate

Bernasconi.ch

Boden Decke Wände

Prüfbericht Oktober 2019
NR. 9060006

$\mu > 0.60 = \text{GS4/GB3 R12/13 C}$

Bemerkung: Die Platten können in
Bereichen von GB 3 eingesetzt werden.



Russia - Hygiene Certificate

Russia - Hygiene Certificate



Ukraine - Sepro Certificate



Ukraine - Sepro Certificate For Facade



France - CSTB NF UPEC

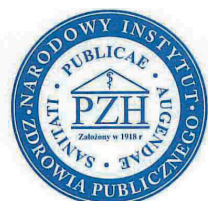

Poland Hygiene Certificate

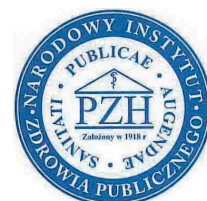

Poland Radiation Certificate

GENEL MERKEZ

Paşalimanı Caddesi
Hüseyin Baykara Sokak No:1
Üsküdar - İstanbul

T: +90 212 340 74 00
F: +90 212 258 73 05

info@seranit.com.tr
export@seranit.com.tr

İSTANBUL MAĞAZA

E5 Karayolu Bostancı Kavşağı
İçerenköy Mh. Kartal Sk. No:3
Bostancı / İstanbul Türkiye

T: +90 216 577 74 53

İZMİR MAĞAZA

Cengiz Topel Mahallesi
Gaziler Caddesi No:560
Yenişehir / Konak - İzmir

T: +90 232 457 50 00

ADANA MAĞAZA

Kurtuluş Mahallesi
Ziyapaşa Bulvarı
Refah Apartmanı Kapı No:23/1A
Seyhan / Adana

T: +90 212 340 74 00

LONDRA SHOWROOM

Turkish Trade Center
26-29 St Cross Street, London,
EC1N8UH

DUBAI SHOWROOM

Al Quoz 2 Industrial Area,
MAG Warehouse Complex,
Al Quoz Logistics Park
Plot# 911 Store 6
Dubai -UAE

SERANIT USA LLC

11417 IL-19 Franklin Park
IL 60131
T: +1 312 826 0544

SERANIT FRANCE

Seranit Granit Seramik Sanayi AS
23 Rue Du Roule 75001 Paris 1

sera**nit**